

Two-hand control station JSTD25 with Safeball

The JSTD25 replaces the traditional two-hand device. With the JSTD25 control station you have a prepared two-hand unit that is easy to install, while utilizing the good ergonomics of the Safeball. There are several versions to meet differing needs, all versions meet EN 574 and EN ISO 13849-1.

For mobile or fixed installation

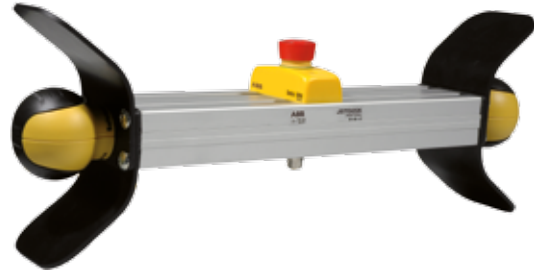

JSTD25F/JSTD25H

Article number - 2TLA020007R6000/2TLA020007R6300

An ergonomic two-hand control unit with two Safeballs mounted on the ends of an aluminum profile. Both Safeballs are protected with shields for unintended press of the Safeball buttons. The device can be easily mounted with the aid of grooves in the aluminum profile and a quick connection is made to the M12 connector underneath the device. For mobile applications with repositioning of the two hand device this unit is very suitable because of its low weight.

JSTD25F is equipped with a 5-pole M12 male connector and the JSHD25H is equipped with an 8-pole M12 male connector.

Both units can be equipped with an external emergency stop (Smile) and an Eden sensor for position control (ordered separately and assembled by the customer).

JSTD25K

Article number - 2TLA020007R6900

The JSTD25K is a fully equipped two-hand control device that is very similar and has all the advantages from the JSTD25F/ JSTD25H.

JSTD25K has just as JSTD25F/H, two Safeballs mounted on the ends of an aluminum profile and the same length. The additional equipment is double protection shields protecting for unintended press from several directions and a Smile 10 EA emergency stop placed on the middle of the profile. Connection is made easily with a 8-pole M12 male connector underneath the device.

10

For mobile installation with a built-in Eden sensor

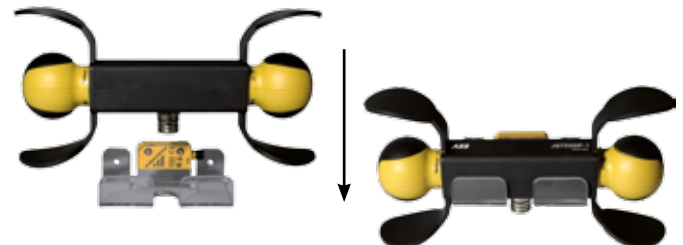

JSTD25P-1

Article number - 2TLA020007R6500

Two-hand control unit, portable. Two Safeballs mounted on the ends of an aluminium profile, shielded by over hand guards. With built-in Eva sensor for position control. Developed as a portable two-hand device, where the response of the

machine to operation can vary at different operating stations, since each station can be connected separately. Connection via an 8+1 Zylind connector.

Accessories

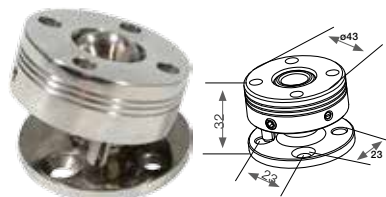

JSM C5

Article number - 2TLA020007R0900
Angled ball joint for installation of a Safeball on a table or a steel housing.

JSM C7

Article number - 2TLA020007R1200
Suspension shelf for JSTD25F/H/G/K

JSM C14

Article number - 2TLA020007R8000
Suspension shelf for JSTD25P-1



JSTK25S

Article number - 2TLA020007R6700
2.5 m long spiral cable for JSTD25P-1

JSTK50S

Article number - 2TLA020007R6800
8 m long spiral cable for JSTD25P-1

JSTK0-A

Article number - 2TLA020007R6600
Female connector for JSTD25P-1



Safeball protection coat

Article number - 2TLA020007R1900
Extra protection coat for Safeball.

Connection examples

JSTD25F

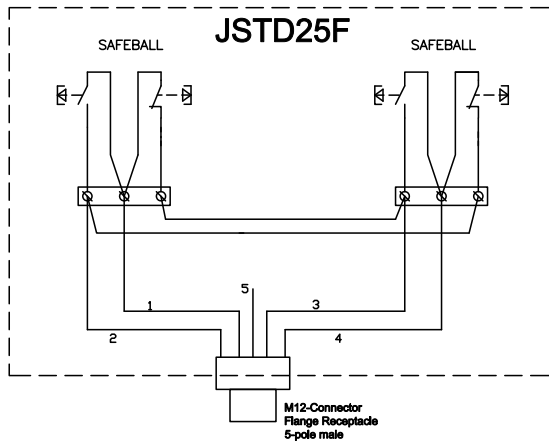

M12 5 Color-code
(not always used, verify!)
1 Brun Brown Braun Marron
2 Vit White Weiss Blanc
3 Blå Blue Blau Bleu
4 Svart Black Schwartz Noir
5 Not connected

1 Dyn A out
2 Pluto to evaluate A = OK, and test B (two inputs)
3 Pluto to evaluate B = OK, and test A (two inputs)
4 Dyn B out

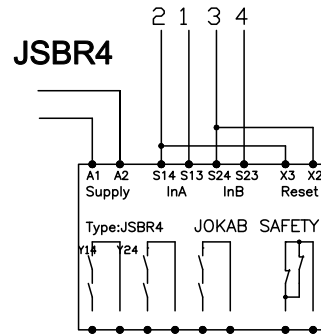

PLUTO

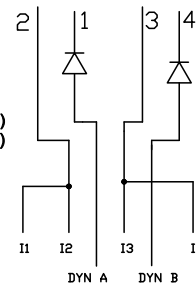

According to standard Pluto Twohand1 block:
I1: Right_NO
I2: Left_NC
I3: Right_NC
I4: Left_NO

JSTD25H

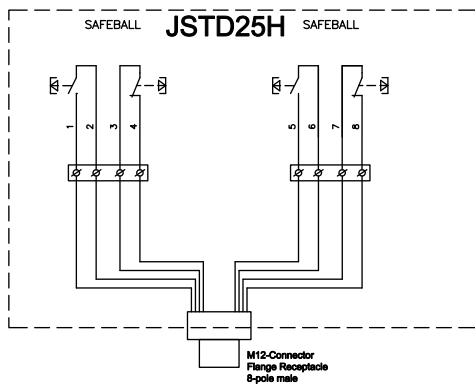

M12-C03
Contact (plug) for self assembly, Female.
As seen from cable side (trace).
Ordered separately.

M12 8 Color-code
(not always used, verify!)
1 Vit White Weiss Blanc
2 Brun Brown Braun Marron
3 Grön Green Grün Vert
4 Gul Yellow Gelb Jaune
5 Grå Grey Grau Gris
6 Rosa Pink Rosa Rose
7 Blå Blue Blau Bleu
8 Röd Red Rot Rouge

PLUTO

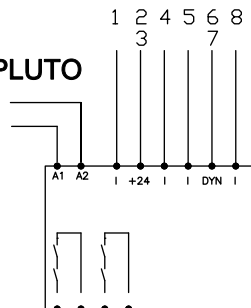

JSBR4

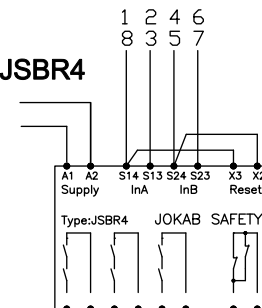

Connection examples

JSTD25P-1

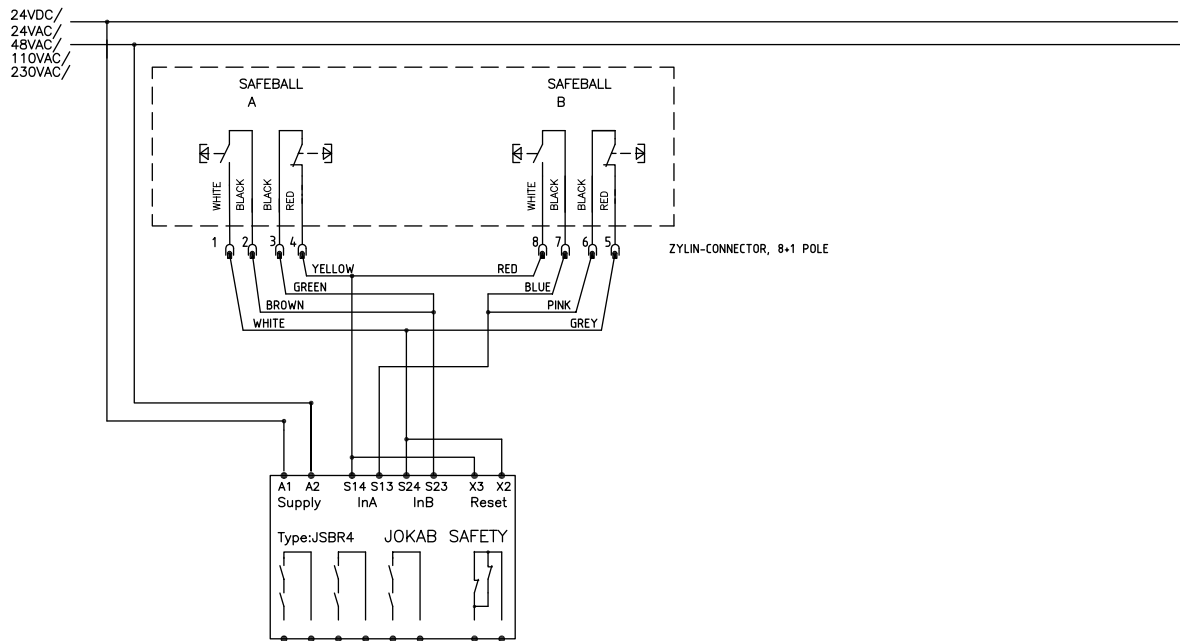

Dimensions

JSTD25

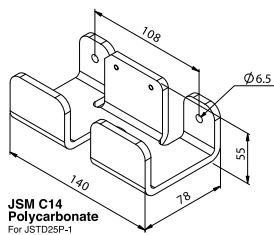
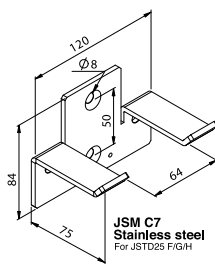

JSTD25F

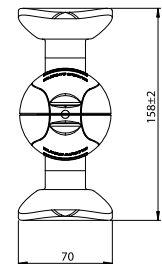
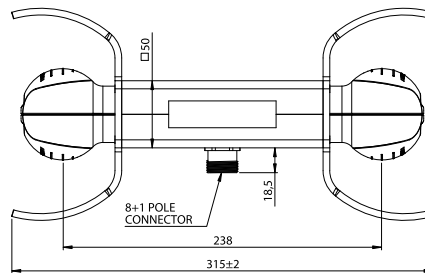
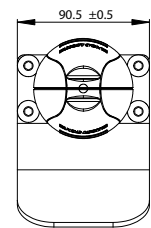
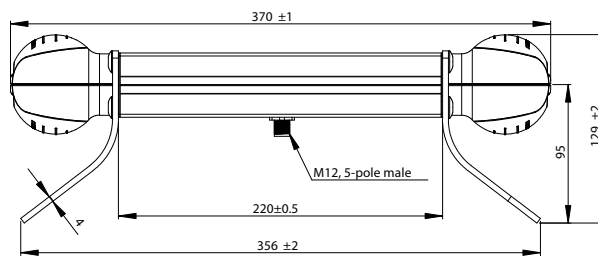

JSTD25P-1